

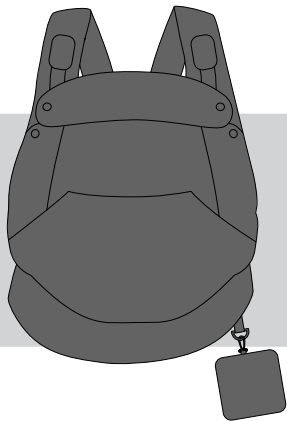

LAYA CARRIER

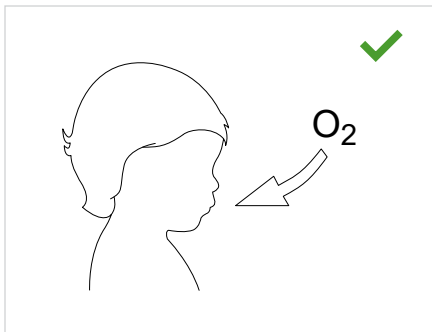

Download the
CYBEX app
and register your
product to unlock
your benefits

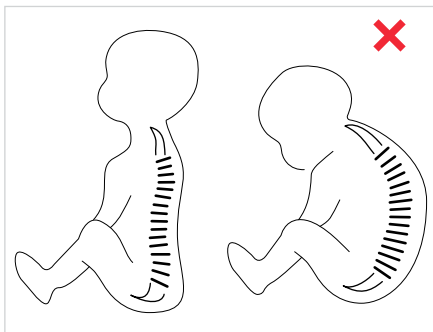

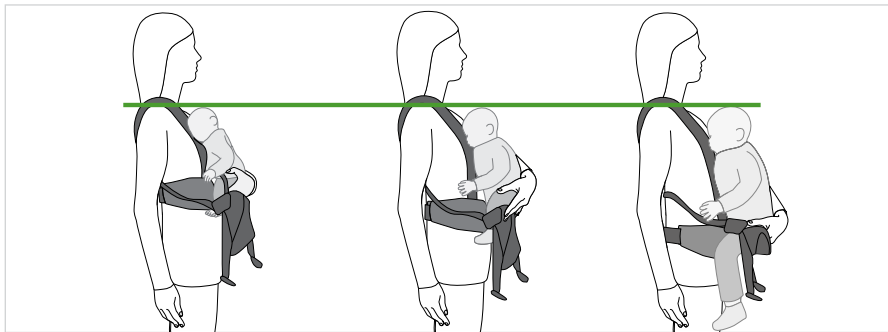

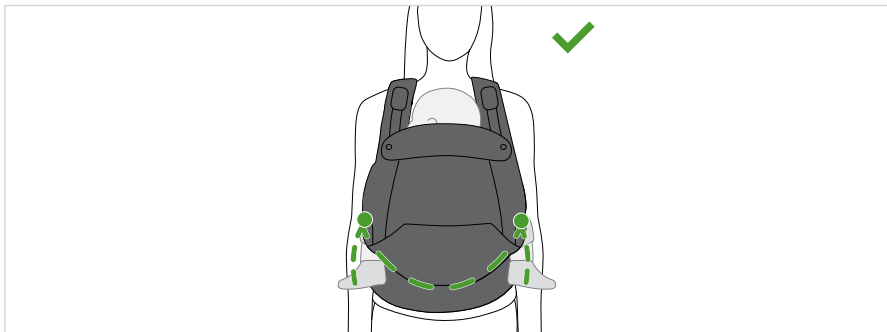

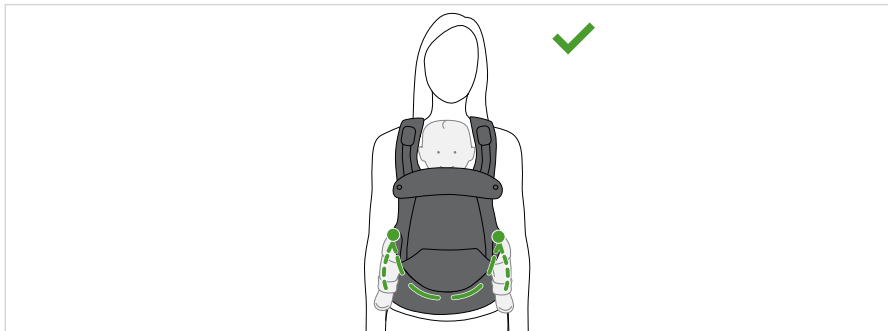



0 - 6 Mo.

Min. 3,2 kg (7 lb)



6 - 36 Mo.

Max. 15 kg (33 lb)



EN WARNING
DE WARNUNG
ES ADVERTENCIA
FR AVERTISSEMENT
PT AVISOS
IT ATTENZIONE
NL WAARSCHUWING
PL OSTRZEŻENIE
CZ UPOZORNĚNÍ
SK UPOZORNENIE
SL OPOZORILO
HR UPOZORENJE
HU FIGYELMEZTETÉS
SE VARNING
NO ADVARSEL
FI VAROITUS
DA ADVARSEL
ET HOIATUS
LV BRĪDINĀJUMS
LT PERSPĖJIMAS
RU ВНИМАНИЕ
UK УВАГА
TR UYARI
EL ΠΡΟΕΙΔΟΠΟΙΗΣΗ
RO AVERTISMENTE
IS VIÐVÖRUN
MT TWISSIJA

AR
FA
YUE 警告
CMN 警告
JA 警告
KO 경고
BG ПРЕДУПРЕЖДЕНИЕ
SR UPOZORENJE
MS AMARAN
HI चेतावनी
TH คำเตือน
SQ PARALAJMËRIM
BS UPOZORENJE
ME UPOZORENJE
MK ПРЕДУПРЕДУВАЊЕ
HY ՉԳՈՒԸԱՑՈՒՄ
VI CẢNH BÁO

تحذير
اخطار



EN Tutorial video
DE Videoanleitung
ES Tutorial en video
FR Vidéo de démonstration
PT Video tutorial
IT Video tutorial
NL Instructievideo
PL Film instruktażowy
CZ Výukové video
SK Výukové video
SL Video z navodili
HR Video s uputama
HU Bemutatóvideó
SE Videosjälvstudiekurs
NO Oppføringsvideo
FI Opetusvideo
DA Vejledende video
ET Õppevideo
LV Ar mācību video
LT Mokomasis vaizdo įrašas
RU Обучающее видео
UK Навчальне відео
TR Öğretici video
EL Εκπαιδευτικό βίντεο
RO Video tutorial
IS Kennslumyndband
MT Tutorial fuq vidjow

AR

FA

YUE 教程視頻

CMN 教程视频

JA チュートリアルビデオ

KO 튜토리얼 동영상

BG Учебно видео

SR Video sa uputstvima

MS Video tutorial

HI ट्यूटोरियल वीडियो

TH รั้ตโ้ไอแนะน่า

SQ Video udhëzuese

BS Video sa uputstvima

ME Video sa uputstvima

MK Видеоупатство

HY Ուսումնական տեսանյութ

VI Video hướng dẫn

فیدو تعلیمی
ویدئوی آموزشی



$$\begin{array}{|c|} \hline \square \\ \hline \square \\ \hline \square \\ \hline \square \\ \hline \end{array} = 11$$



$$\begin{array}{|c|} \hline \square \\ \hline \square \\ \hline \square \\ \hline \square \\ \hline \square \\ \hline \end{array} = 19$$



$$\begin{array}{|c|} \hline \square \\ \hline \square \\ \hline \square \\ \hline \square \\ \hline \square \\ \hline \end{array} = 22$$



$$\begin{array}{|c|} \hline \square \\ \hline \square \\ \hline \square \\ \hline \square \\ \hline \square \\ \hline \square \\ \hline \end{array} = 30$$



$$\begin{array}{|c|} \hline \square \\ \hline \square \\ \hline \square \\ \hline \square \\ \hline \square \\ \hline \square \\ \hline \end{array} = 33$$



$$\begin{array}{|c|} \hline \square \\ \hline \square \\ \hline \square \\ \hline \square \\ \hline \square \\ \hline \square \\ \hline \square \\ \hline \end{array} = 37$$

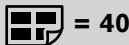

EN Using the neck support
DE Verwendung der Nackenstütze
ES Uso del soporte para el cuello
FR Utilisation de l'appui-nuque
PT Utilização do suporte do pescoço
IT Utilizzo del supporto per il collo
NL De nekondersteuning gebruiken
PL Korzystanie z podparcia szyi
CZ Použití krční opěrky
SK Používanie podpery krku
SL Uporaba opore za vrat
HR Korištenje potpore za vrat
HU A nyaktámasz használata
SE Använda nackstödet
NO Bruke nakkestøtten
FI Niskatuen käyttäminen
DA Brug af nakkestøtte
ET Kaelatoe kasutamine
LV Kakla atbalsta izmantošana
LT Kaklo atramos naudojimas
RU Использование опоры для шеи
UK Використання підтримки шиї
TR Boyun desteğinin kullanımı
EL Χρήση του στηρίγματος αυχένα
RO Utilizarea suportului pentru ceafă
IS Að nota hálsstuðninginn
MT Kif tuża l-appoġġ għall-għonq

AR استخدام وسادة الرقبة
FA استفاده از ساپورت گردن
YUE 使用頸托
CMN 使用颈托
JA ネットサポートの使い方
KO 목 받침대 사용
BG Използване на опората за врата
SR Upotreba naslona za vrat
MS Menggunakan penyokong leher
HI नेक सपोर्ट का उपयोग करना
TH การใช้อุปกรณ์พยุงคอ
SQ Përdorimi i mbajtëses së qafës
BS Korištenje potpore za vrat
ME Korišćenje naslona za vrat
MK Употреба на потпирачот за вратот
HY Վզի հենասարքի օգտագործումը
VI Sử dụng tấm đỡ cổ

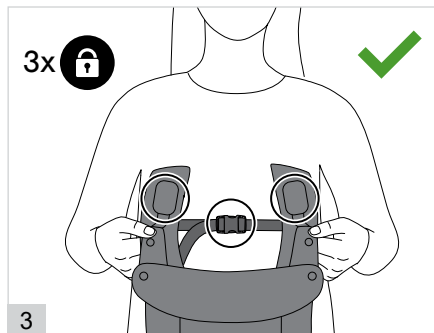
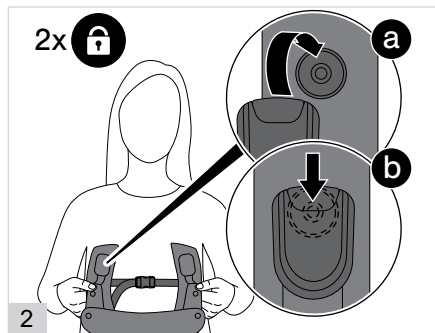
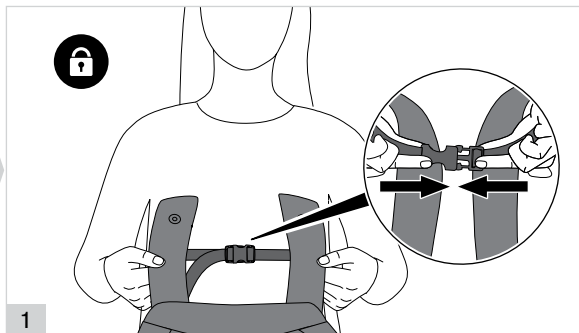

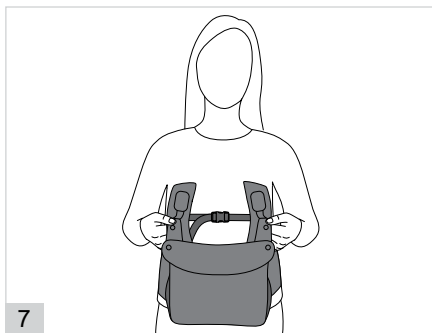
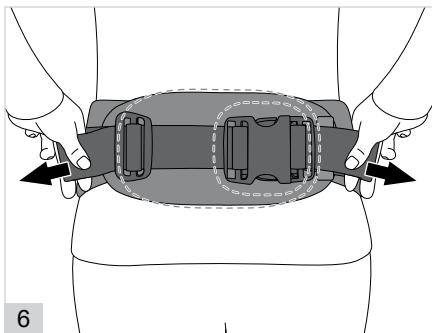
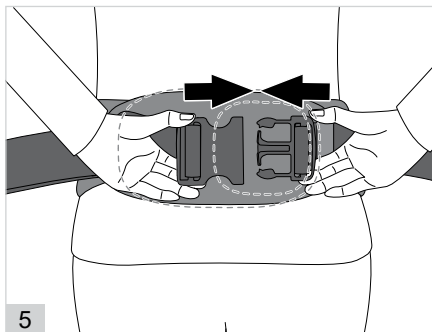
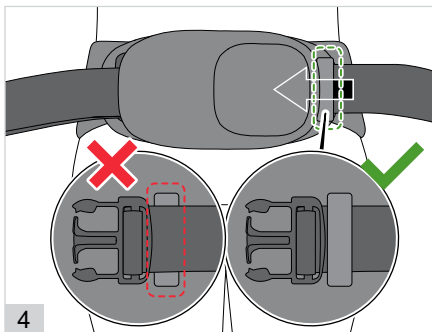

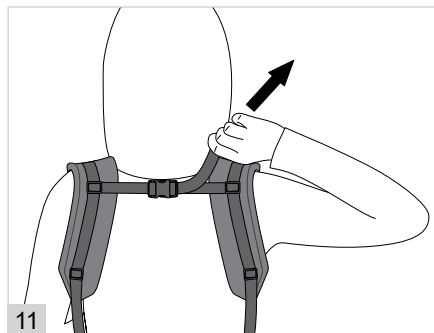
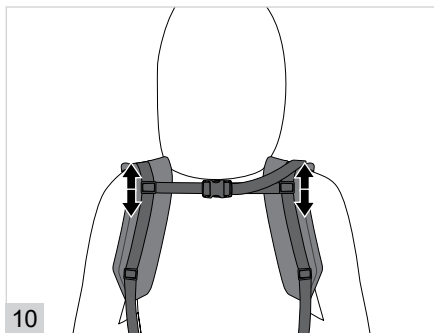
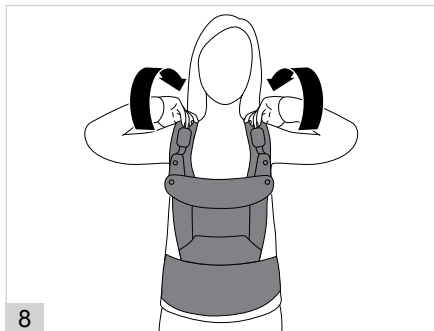

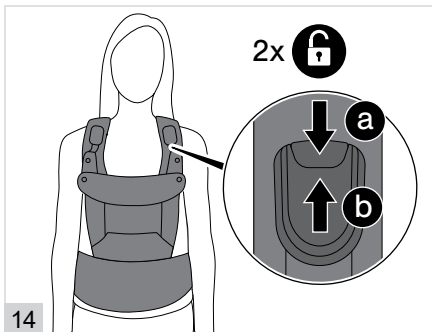
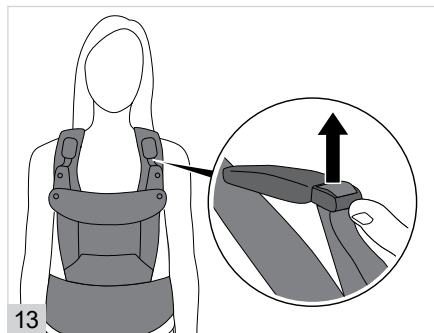

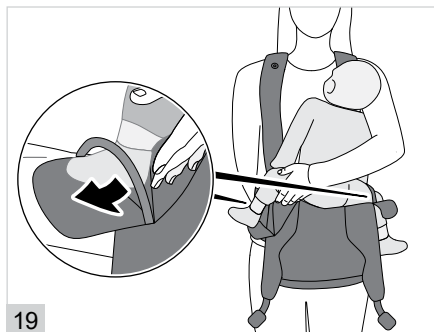
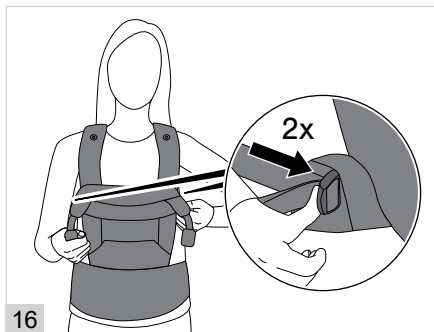

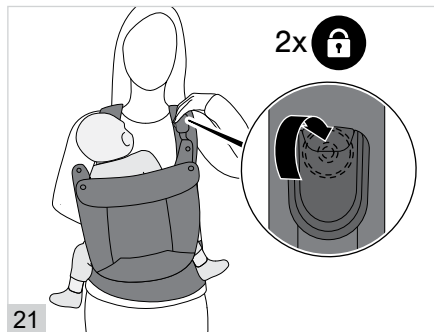

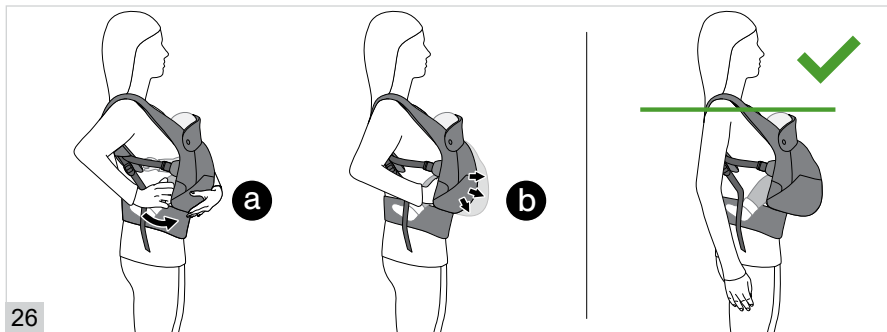
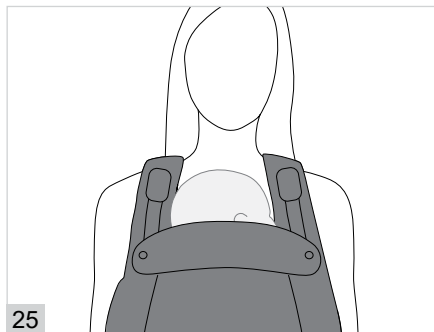
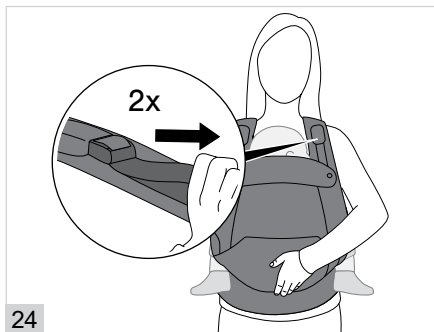

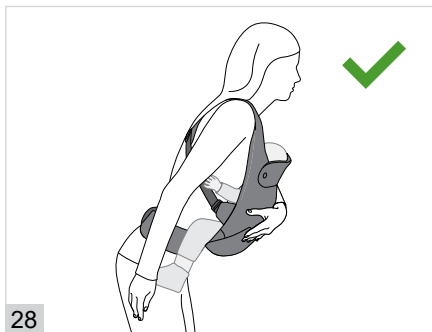
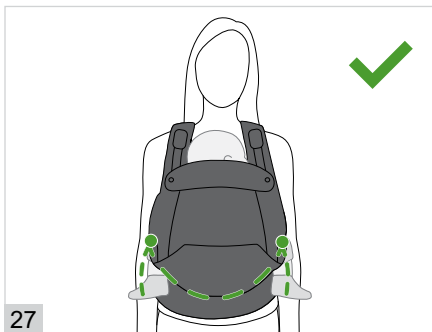

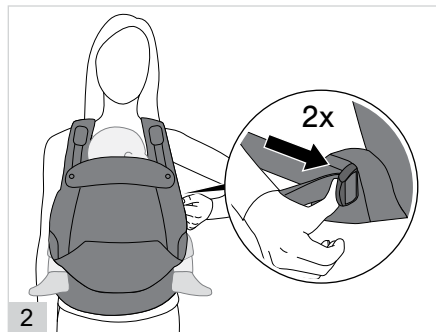

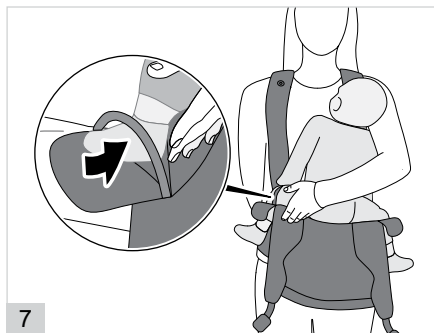
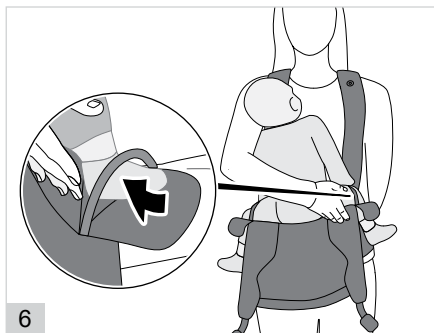
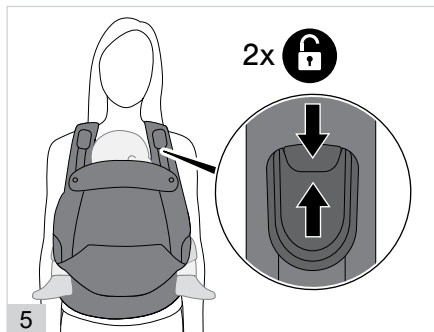
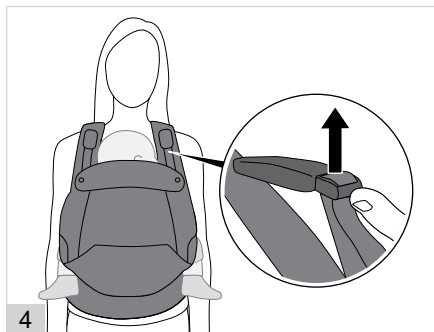

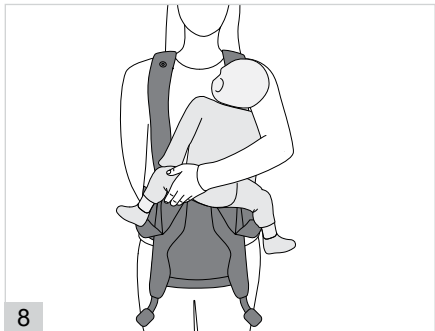

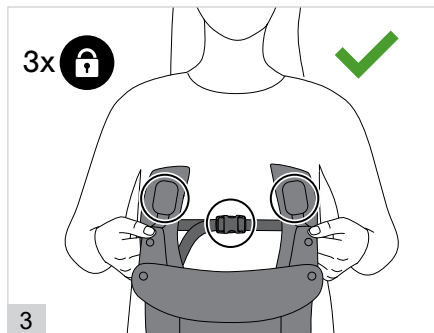
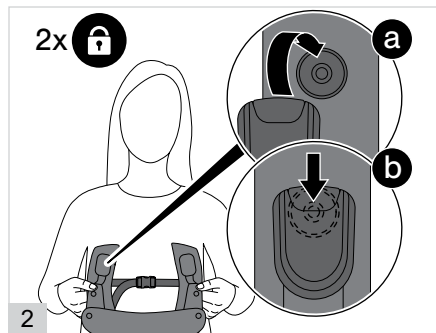
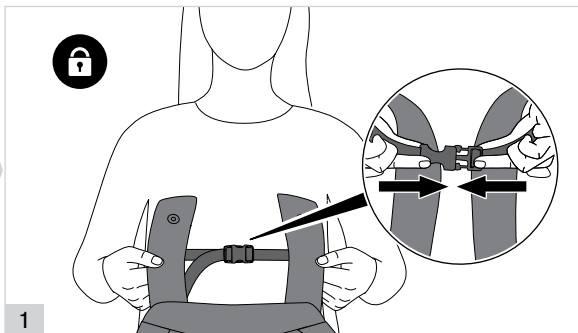

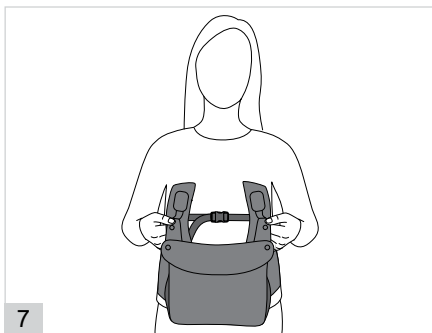
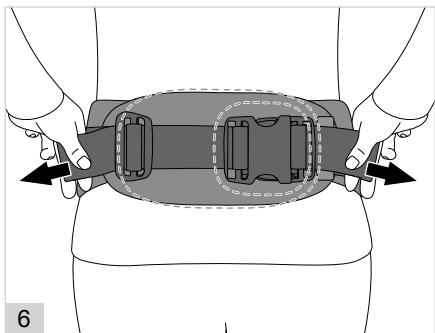
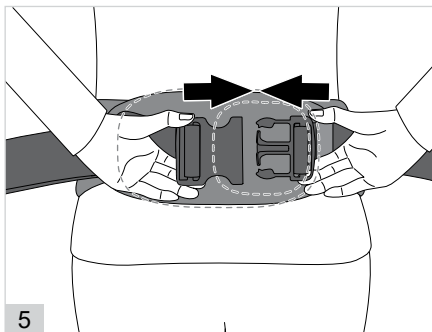
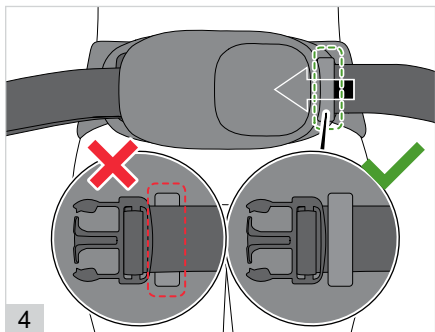

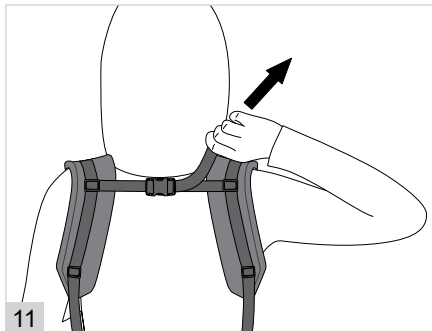
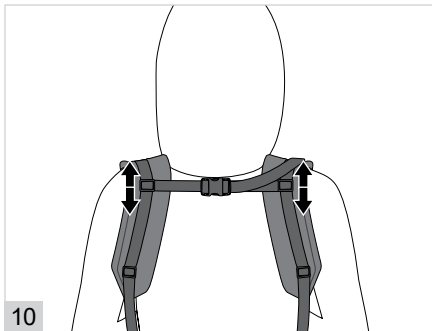
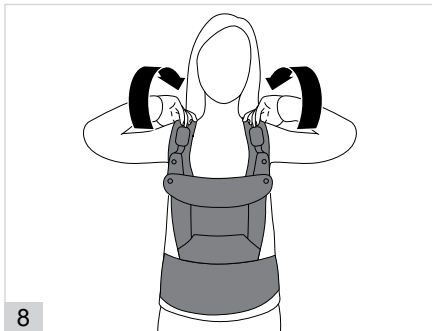

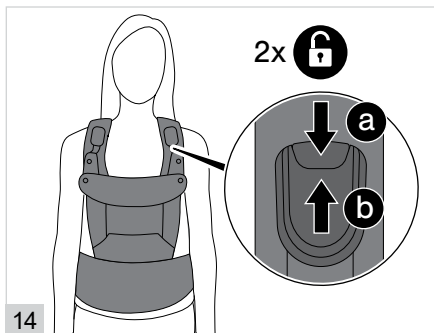
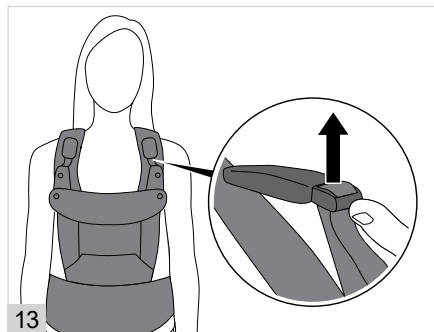

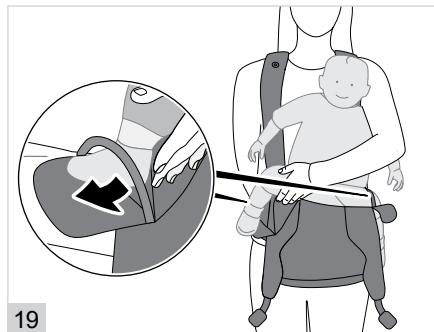
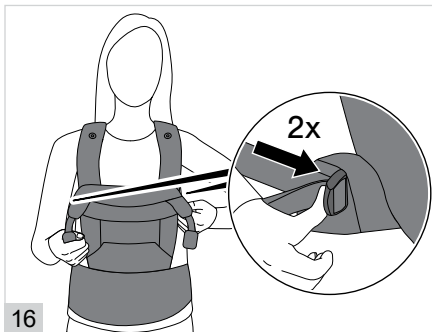

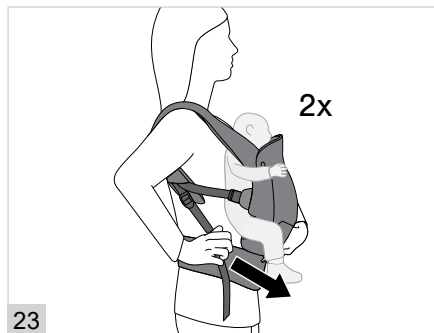
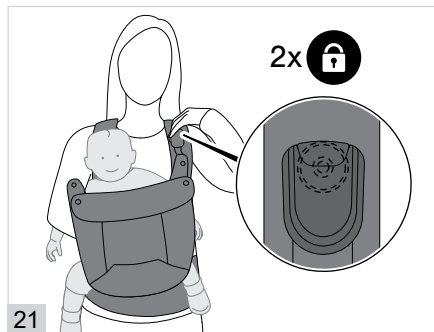

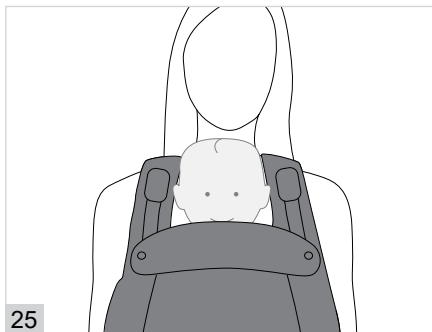
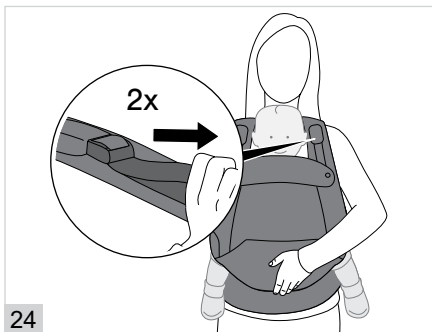

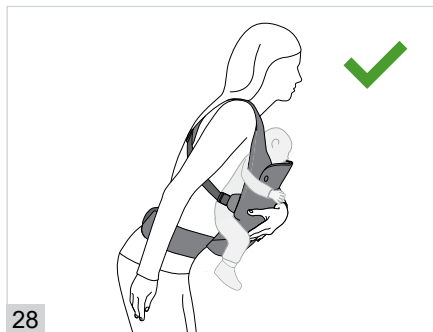
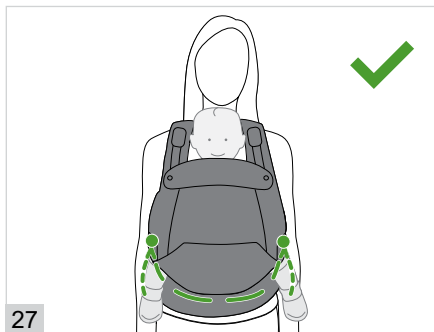

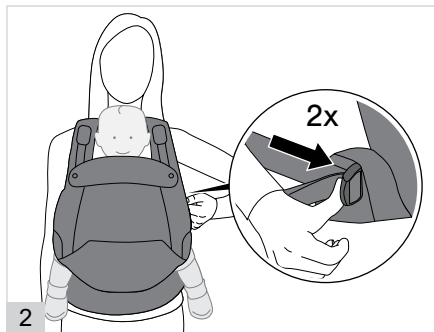

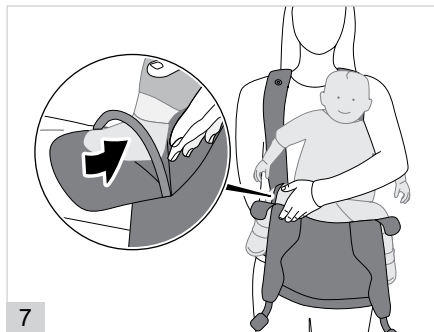
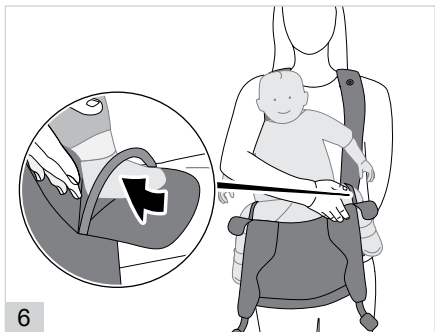
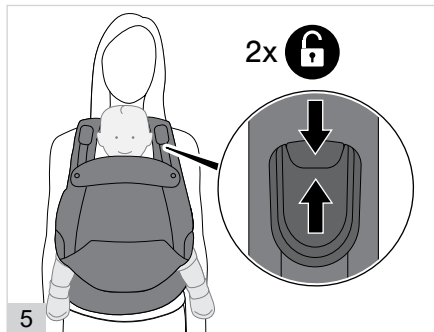
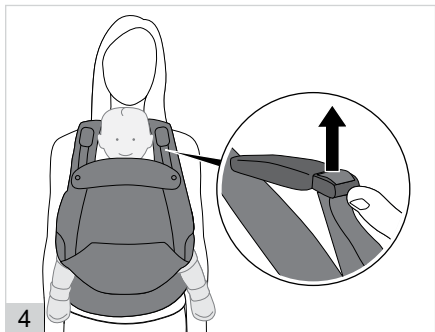

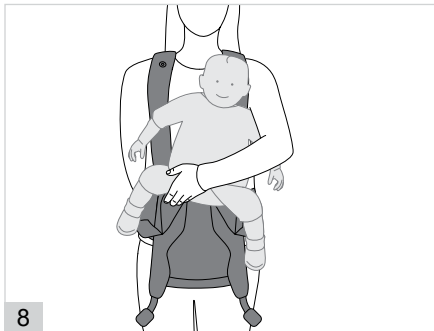

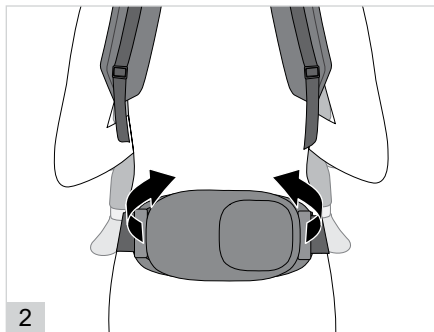
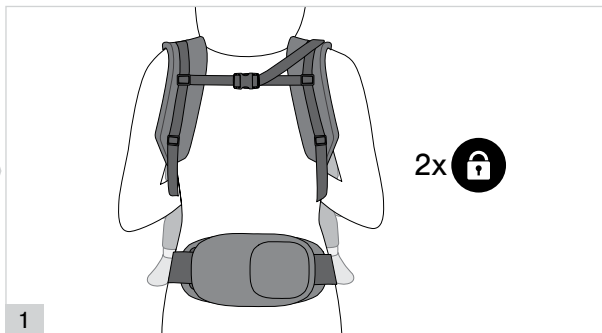

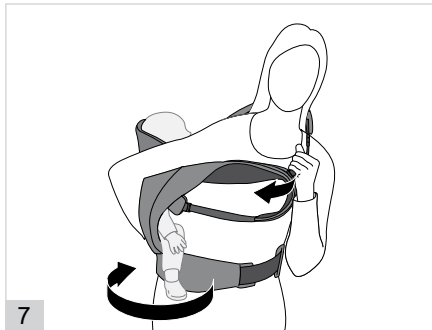

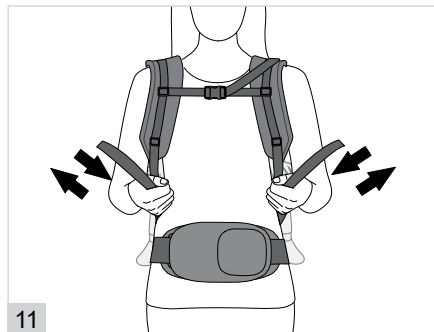

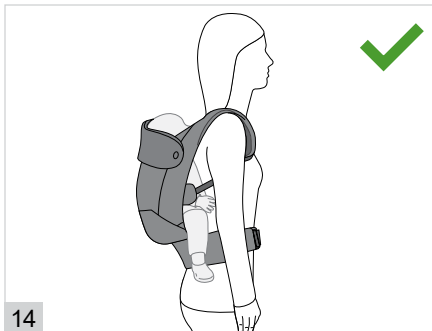
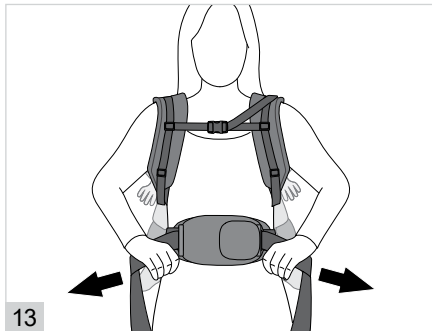
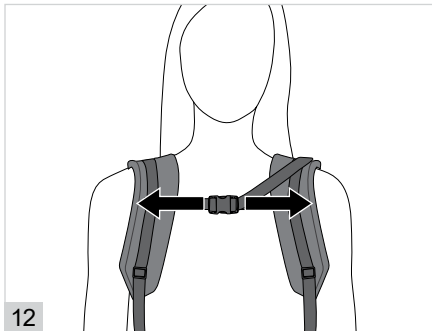

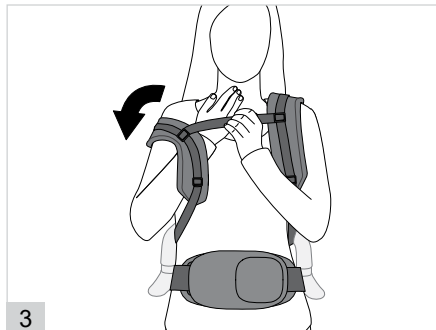
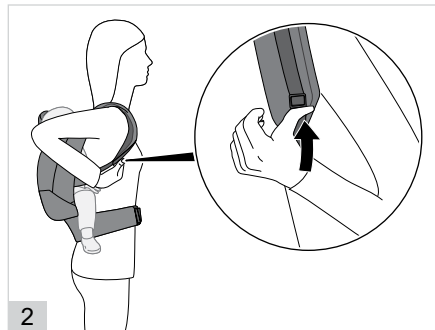
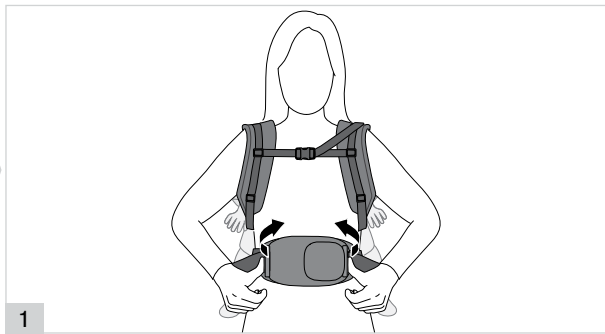

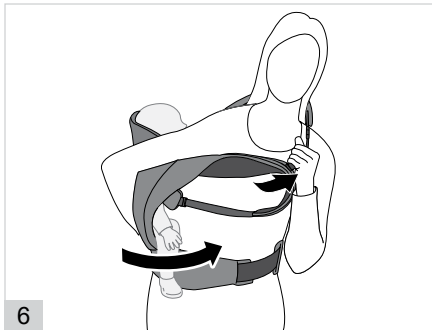
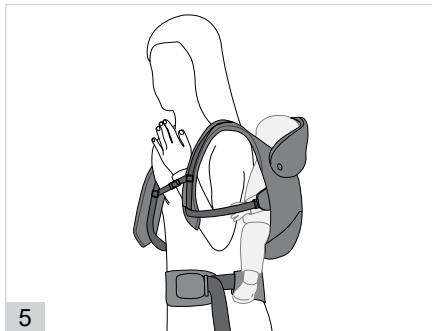

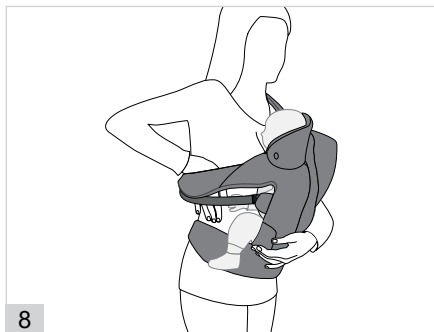

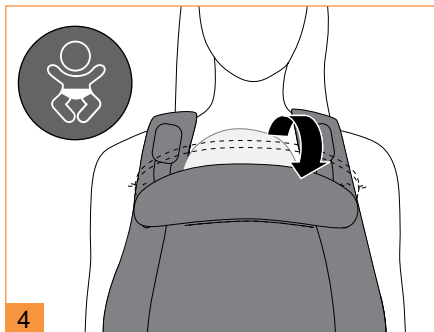
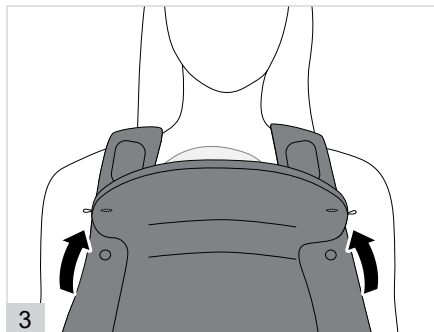
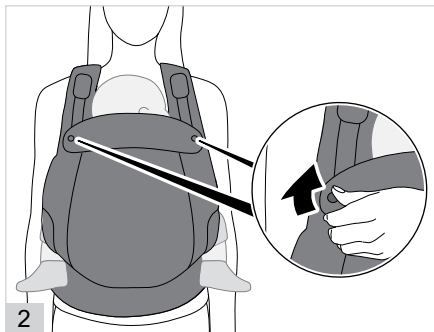

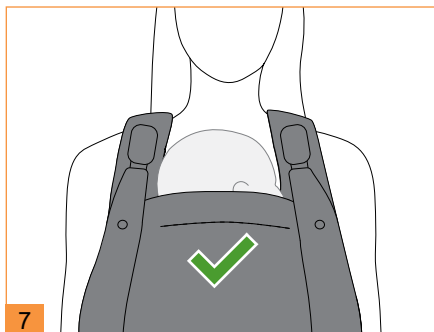
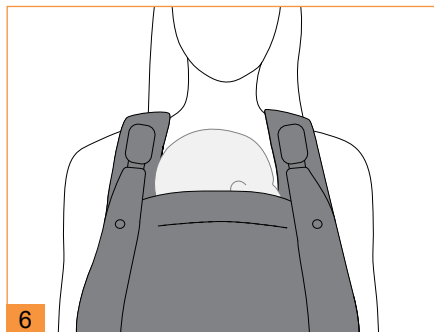
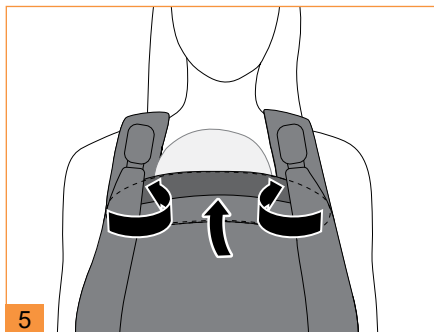

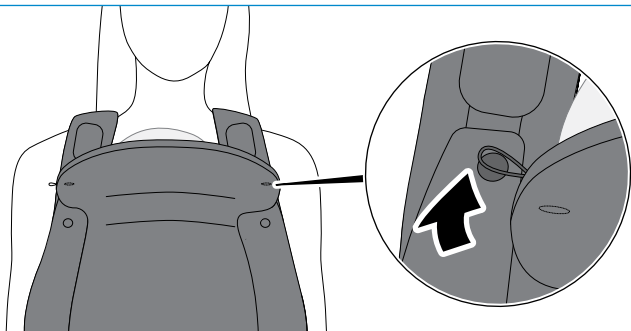

4

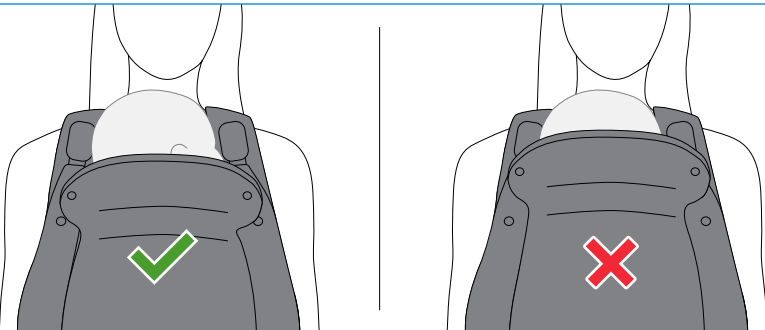

5



EUROPE AND ASIA

CYBEX GmbH
Riedingerstraße 18
95448 Bayreuth, Germany
+49 (0) 921-78 511 - 0
info@cybex-online.com

AMERICAS

Columbus Trading-Partners USA Inc.
2915 Whitehall Park Drive, Suite 300,
Charlotte, NC 28273, USA
Customer Service: 1-877-242-5676
info.us@cybex-online.com

CANADA

Columbus Trading-Partners Canada Inc.
199 Bay Street, 5300 Suite,
Commerce Court West
Toronto, ON, M5L 1B9, Canada
Customer Service: 1-877-242-5676
info.us@cybex-online.com

AUSTRALIA AND NEW ZEALAND

Partners In Prime Pty Ltd
Suite 127 / Mezzanine
32 York Street, Sydney NSW 2000
Customer Service: 13-0005-6520
support@partnersinprime.com



quefairedemesdechets.fr